



RINOX

DIAPHRAGM PRESSURE REDUCING VALVE

CT0051.0_08
EN
March 2015



PRODUCTION RANGE

"RINOX FF" PRESSURE REDUCING VALVE

Code	Size	Connection	P _{max} before	P _{after} adjustable	Preset P	On request	
						P _{after} adjustable	Preset P
51.04.70*	G 1/2"	FF UNI-EN-ISO 228	4000 kPa [40 bar] (1600 kPa [16 bar] in accordance with standard NF)	80÷550 kPa [0,8÷5,5 bar]	300 kPa [3 bar]	80÷700 kPa [0,8÷7 bar]	-
51.05.70*	G 3/4"						
51.06.70	G 1"						
51.07.70	G 1 1/4"						
51.08.70	G 1 1/2"						
51.09.70	G 2"						
51.10.70	G 2 1/2"						
51.11.10	DN 80	Flanged					
51.10.10	DN 65						
51.13.10	DN 100						

"RINOX MM" PRESSURE REDUCING VALVE

51.04.10*	G 1/2"	MM UNI-EN-ISO 228 with coupling	4000 kPa [40 bar] (1600 kPa [16 bar] in accordance with standard NF)	80÷550 kPa [0,8÷5,5 bar]	300 kPa [3 bar]	80÷700 kPa [0,8÷7 bar]	-
51.05.10*	G 3/4"						
51.06.10	G 1"						
51.07.10	G 1 1/4"						
51.08.10	G 1 1/2"						
51.09.10	G 2"						

"RINOX KIT"

111.04.00*	G 1/2"	FF UNI-EN-ISO 228	1600 kPa [16 bar] (value limited by the filter included in the kit)	80÷550 kPa [0,8÷5,5 bar]	300 kPa [3 bar]	80÷700 kPa [0,8÷7 bar]	-
111.05.00*	G 3/4"						
111.06.00	G 1"						
111.07.00	G 1 1/4"						
111.08.00	G 1 1/2"						
111.09.00	G 2"						

ACCESSORIES

Code	Description
1213.005	 Radial gauge ø 50 mm. Scale range: 0 ÷ 16 bar. Connection: 1/4"

* Satisfies EN 1567 and NF  (France) type-approved (Sizes 1/2" and 3/4" only). For the Rinox Kit, the certification applies only to the Rinox pressure reducer.
 ** ACS conformity "Attestation de Conformité Sanitaire" (France) according to DGS/SD7A n°571 of 25/11/2002
 *** Korea water and wastewater works association

DESCRIPTION

The *RBM Rinox* pressure reducing valve range are diaphragm pressure reducers, with a compensation chamber.

PURPOSE

The main purpose of *RBM Rinox* pressure reducing valves is to reduce the fluid pressure to optimum operating values, constantly below the maximum permitted values so as not to damage equipment fitted after the reducing valve.

USE

Rinox RBM Pressure Reducing Valve is **an adjustment unit and not a security unit**. In order to guarantee this task, it is necessary to supply the system with suitable security unit.

RBM Rinox pressure reducing valves are especially recommended for use in heating-plumbing systems. In particular they are recommended for reducing the pressure between the distribution mains and the main use derivations.

Pressure reducing valves are especially recommended if used in circuits where the upstream pressure is subject to oscillations (water hammering).

CHOICE

The *RBM Rinox* pressure reducing valve range is recommended for use in heating-plumbing systems with inlet pressures no higher than 40 bar.

The downstream pressure regulation can be either 80÷550 kPa or 80÷700 kPa, depending on the models.

The reducing valve also has a shutter double seal seat which guarantees optimum pressure regulation control.

The correct choice of the number of pressure reducing valves necessary to obtain the pressure reduction, is important to avoid cavitation phenomena.

These phenomena in fact cause excessive noise in the reducing valve with consequent disturbances to users and possible damage to the reducing valve itself.

For this reason, please refer to the dedicated section inside the technical sheet for the optimum choice of the number of reducing valves in function to the pressure differential to be obtained.

CERTIFICATIONS

All components suitable for the conveyance of drinkable fluids are provided with a certification stating their compliance with Ministerial Decree **DM 174/04** and with the **A.C.S** French Standards on the suitability of materials coming into contact with fluids intended for human consumption.

CONSTRUCTION CHARACTERISTICS

• Body:	Brass CW 617N UNI EN 12165
• Seal seat:	Stainless steel AISI 303
• N° of shutter seal seats:	1
• N° of piston sliding seal seats:	1
• Internal component metal:	Brass CW614N UNI EN 12164
• Rod:	Brass CW614N UNI EN 12164
• Diaphragm:	NBR nitrile elastomer
• Seals:	NBR nitrile elastomer
• Plastic parts:	Nylon 6 with 30% fibre glass
• Gauge attachment connection:	F G 1/4"

TECHNICAL CHARACTERISTICS

• Compatible fluid:	Water
• Nominal pressure:	PN40
• Maximum inlet pressure:	4000 kPa – 40 bar (Rinox and Rinox Kit); 1600 kPa – 16 bar (Rinox Kit) (value limited by the filter included in the Kit)
• Inlet pressure in accordance with standard NF	1600 kPa – 16 bar (Rinox and Rinox Kit);
• Adjustable outlet pressure:	80÷550 kPa – 0,8÷5,5 bar or 80÷700 kPa – 0,8÷7 bar, depending on model
• Factory presetting:	300 kPa only for model with adjustable outlet pressure: 80÷550 kPa – 0,8÷5,5 bar
• Maximum operating temperature:	80°C
• Connections:	UNI-EN-ISO 228 FF or MM thread, depending on model
• Filter:	Stainless steel AISI 304
• Filtration:	800 µm (Rinox Kit)
• Anti-hammering action	Yes
• Acoustic unit	2 (23 dB (A) for 1/2" and 3/4")

RINOX KIT - COMPOSITION



Pressure reducing group in Kit, composed of:

- Rinox pressure reducing valve. Sizes: 1/2", 3/4", 1", 1" 1/4, 1" 1/2, 2";
- Dial gauge;
- Line filter with extractable and changeable UNI-EN-ISO 228 filter cartridge.

DIMENSIONAL CHARACTERISTICS

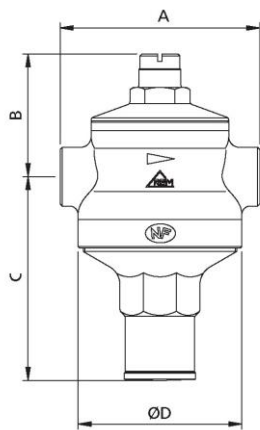

RINOX FF					
CODE	SIZE	A [mm]	B [mm]	C [mm]	Ø D [mm]
51.04.70	1/2"	95	58,5	97	78
51.05.70	3/4"	95	58,5	97	78
51.06.70	1"	95	64,5	101,5	78
51.07.70	1"1/4	116	68,5	165	92,5
51.08.70	1"1/2	122	73	175	92,5
51.09.70	2"	126	73	175	92,5
51.10.70	2"1/2	180	103	274,5	186
51.11.70	3"	188	103	274,5	186
51.13.70	4"	202	103	274,5	186

RINOX FLANGED					
CODICE	MISURA	A [mm]	B [mm]	C [mm]	Ø D [mm]
51.10.10	DN 65	260	103	274,5	186
51.11.10	DN 80	276	103	274,5	186
51.13.10	DN 100	293	103	274,5	186

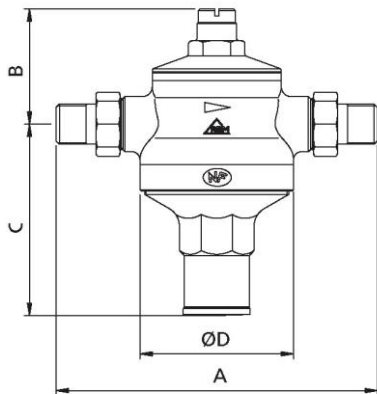

RINOX MM					
CODE	SIZE	A [mm]	B [mm]	C [mm]	Ø D [mm]
51.04.10	1/2"	163	58,5	97	78
51.05.10	3/4"	175	58,5	97	78
51.06.10	1"	185,5	64,5	101,5	78
51.07.10	1"1/4	216,5	68,5	165	92,5
51.08.10	1"1/2	238,5	73	175	92,5
51.09.10	2"	266	73	175	92,5

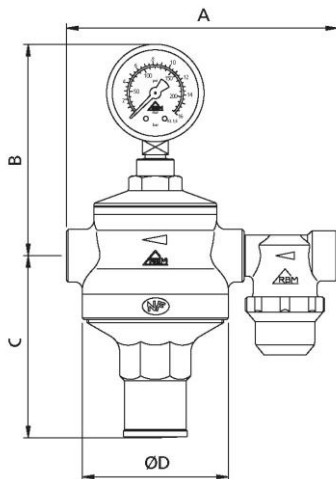

KIT RINOX					
CODICE	MISURA	A [mm]	B [mm]	C [mm]	Ø D [mm]
111.04.00	1/2"	145	113	97	78
111.05.00	3/4"	152,5	113	97	78
111.06.00	1"	166	119	101,5	78
111.07.00	1"1/4	197	123	165	92,5
111.08.00	1"1/2	218,5	127,5	175	92,5
111.09.00	2"	222,5	127,5	175	92,5

OPERATION

The RBM pressure reducer bases its operation on balancing between the antagonist force of the spring and the thrust pressure of the fluid on the diaphragm. In fact, the spring tends to open the reducing valve shutter while the pressure exerted on the useful surface on the diaphragm tends to close the shutter itself.

With their compensation chamber system, RBM pressure reducing valves permit the cancellation of variations which could derive from pressure oscillations in the inlet circuit. In fact, the compensation chamber balances the pressure equally on the ends of the shutter. In this way, the pressure regulation applied by the reducing valve depends solely on the pressure value required downstream.

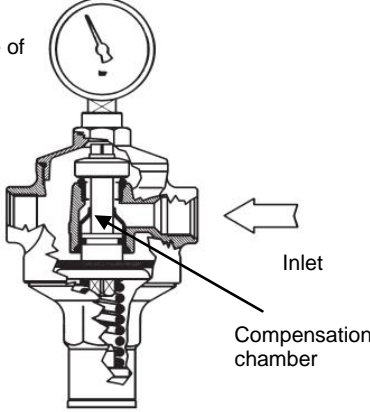
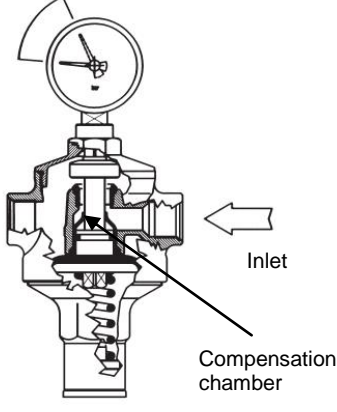
<p>Pressure still at regulation value of 3 bar</p> <p>Outlet: Uses closed</p>  <p style="text-align: right;">Inlet</p> <p style="text-align: right;">Compensation chamber</p> <p>When the uses to be served are closed, the downstream pressure increases, pushing the reducer piston downwards. In this way, the shutter closes the passage section of the reducer maintaining the setting value set on the spring constant; in fact, the minimum pressure difference across the shutter permits the perfect closing of this latter.</p>	<p>Pressure loss: $P < 3$ bar</p> <p>Outlet: Uses open</p>  <p style="text-align: right;">Inlet</p> <p style="text-align: right;">Compensation chamber</p> <p>When the uses are opened downstream, the pressure exerted on the piston is lessened in favour of the force exerted by the spring on the shutter permitting it to open with the constant passage of the fluid. As the water demand from the user network increases the pressure on the piston decreases and more water passes.</p>
--	--

PRESSURE REDUCING VALVE CALIBRATION

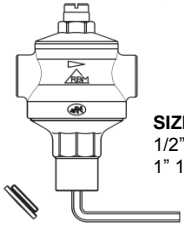
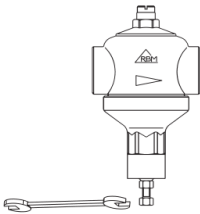
 <p>SIZES: 1/2" - 3/4" - 1" 1" 1/4 - 1" 1/2 - 2"</p>  <p>SIZES: 2" 1/2 - 3" - 4" DN65 - DN80 - DN100</p>	<p>The final calibration of the pressure reducing valve must be performed with the hydraulic circuit completely full and with all the uses closed, otherwise false values would be obtained owing to the fact that the downstream pressure reduces in relation to the necessary flow rate, during any supply.</p> <p>The pressure reducing valve can be calibrated using the internal lock-ring or the external screw: screw clockwise to increase the value, anticlockwise to reduce it.</p> <p>Calibration operations:</p> <ul style="list-style-type: none"> • Close the interception valve after the pressure reducing valve. • Calibrate the pressure reducing valve using a spanner appropriate for the model. • The calibration operation is considered to be complete when the desired pressure is read on the gauge. <p>Warnings:</p> <ul style="list-style-type: none"> • Perform several discharge actions to check the stability of the calibration. • With the system operating, the pressure read at the gauge could be falsified by the overpressure of the thermal system; any correction made should always be performed with the system at a standstill and at ambient temperature.
--	--

FLUID DYNAMIC CHARACTERISTICS

Load loss diagram

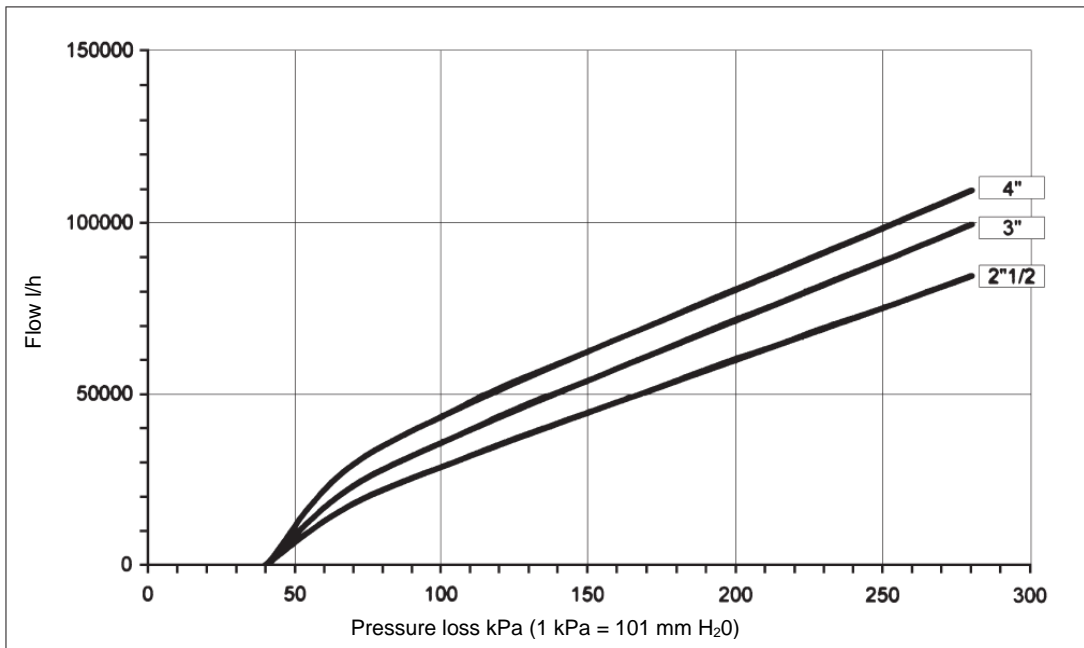
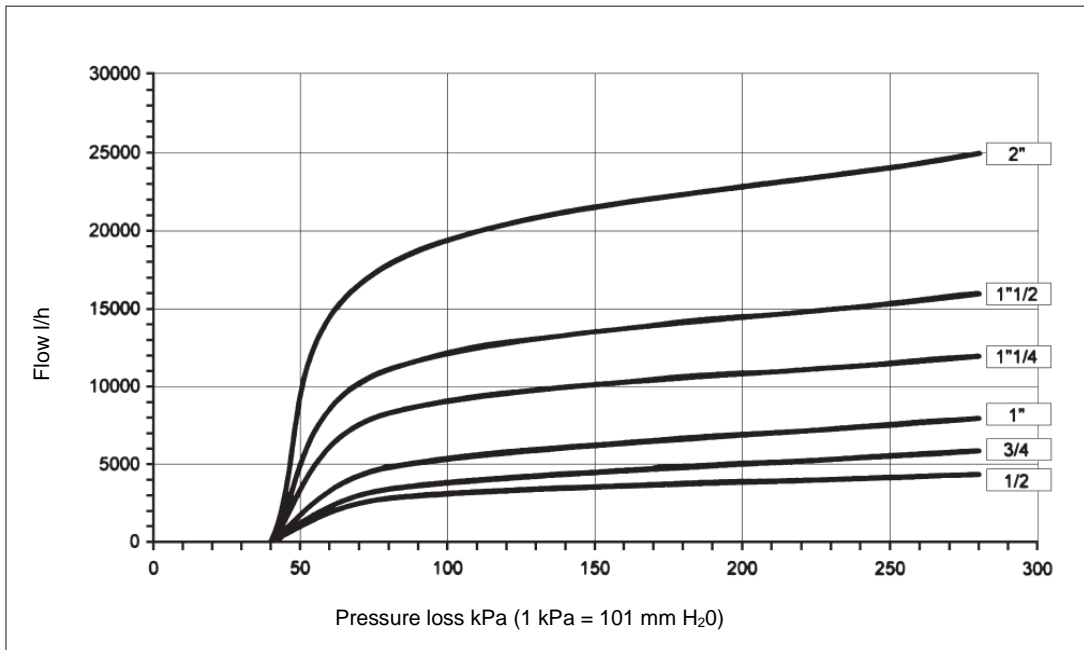

The values described in the diagrams are obtained with:

- Inlet pressure of 800 kPa (8 bar);
- Outlet pressure of 300 kPa (3 bar).

The values shown refer to the performance of just one Rinox pressure reducing valve

READING THE DIAGRAM

The pressure reducing valve load loss diagram represents the pressure loss in function to the flow rate at the user outlets.

EXAMPLE

I consider a 1" pressure reducing valve with a preset pressure of $P = 300$ kPa and I hypothesise a flow rate of $Q = 1.500$ l/h at the user outlets. From the diagram we find that the pressure value is $P_1 = 60$ kPa for this flow rate Q . On the pressure reducing valve gauge we read the following pressure value $P_0 = 300 - 60 = 240$ kPa which represents the pressure value at the user outlets.

SIZING THE PRESSURE REDUCING VALVE

CAVITATION DIAGRAM *

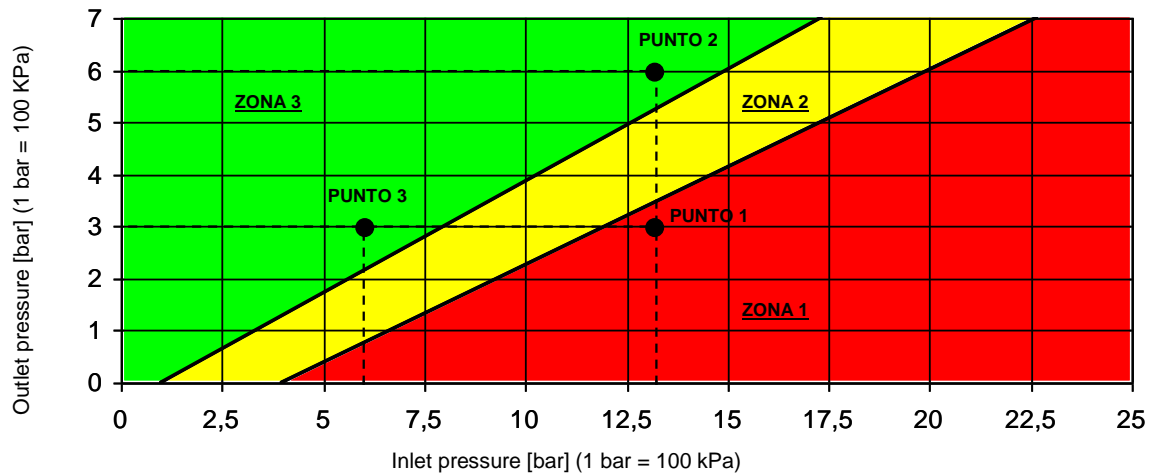

In order to avoid cavitation phenomena and therefore excessive component noise, we recommend choosing the number of pressure reducing valves necessary for a determinate pressure differential, according to the information in the "CAVITATION DIAGRAM". The cavitation diagram shows the three operating zones of the pressure reducing valve in function to the inlet and outlet pressures:

- **ZONE 1: Malfunctioning zone.** The cavitation phenomena are clearly and present inside the pressure reducing valve. We recommend against using the pressure reducing valve at these pressures.
- **ZONE 2: Critical zone.** The possible occurrence of cavitation phenomena inside the pressure reducing valve is evidenced. We recommend against using the pressure reducing valve at these pressures.
- **ZONE 3: Operating zone.** The pressure reducing valve operates in optimum conditions and there is no cavitation. This is the optimum interval of pressure values for the operation of the pressure reducing valve.

In order to avoid cavitation phenomena, we recommend making the pressure reducing valve operate inside ZONE 3, and also, to prevent the ratio between the maximum inlet pressure and the regulation outlet pressure of the pressure reducing valve from exceeding the value of 2.5.

DIMENSIONING

If we want to make a pressure reducing valve work between the following pressure values:

- Inlet P: $P_M = 13$ bar
- Outlet P: $P_V = 3$ bar

As we can see in the diagram, (POINT 1) the pressure reducing valve runs into certain cavitation phenomena at these work pressures.

In order to avoid these phenomena and considering that the ratio between the maximum inlet pressure and the outlet regulation pressure must not exceed the values of 2.5, we could take recourse to introducing a second pressure reducing valve in series, so as to obtain the same pressure differential, via two distinct pressure differentials.

The suggested solution is therefore to use two pressure reducing valves in series which must both work in ZONE 3 of the diagram, to divide the pressure difference over two reduction differentials and where the pressure ratio does not exceed 2.5.

Possible solution:

Pressure reducing valve A [POINT 2]:

- Inlet P: $P_{MA} = 13$ bar
 - Outlet P: $P_{VA} = 6$ bar
- Pressure ratio:** $13/6 = 2,17 < 2,5$

Pressure reducing valve B [POINT 3]:

- Inlet P: $P_{MB} = 6$ bar
 - Outlet P: $P_{VB} = 3$ bar
- Pressure ratio:** $6/3 = 2 < 2,5$

N.B.: The reducer inlet pressure must never be higher than the maximum operating temperature of the components downstream from the pressure reducing valve, so as to avoid damaging them or malfunctioning.-

Apart from acting on the pressure differential, the cavitation phenomena of the pressure reducing valve can also be controlled by choosing an optimum speed value of the fluid passing through it.

We therefore recommend choosing the diameter of the pressure reducing valve so that the speed of the fluid passing through it is between the following values:

- For water: $V = 0,7 \div 1,5$ m/s (residential use)
 $V = 1 \div 3,5$ m/s (industrial use)

N.B: The cavitations diagram is only intended to supply technicians with a rapid, guide reference for associating the chosen component with a given size of system. The values shown in the table are not binding and do not therefore represent the performance limits of the components.

FITTING

Fitting precautions:



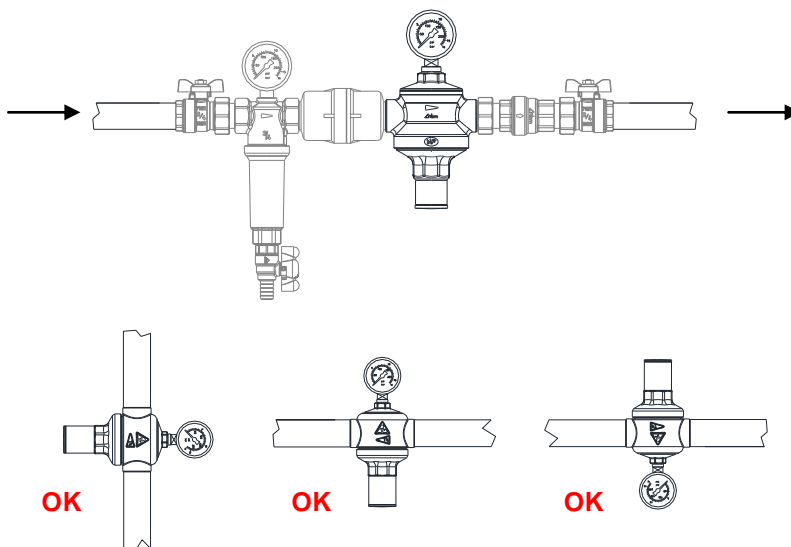







- Always fit a filter before the system.
- Perform ordinary filter maintenance.
- Respect the direction indicated by the flow direction arrow on the body.
- Use interception valves to permit eventual maintenance work.
- Clean the pipes before and after the pressure reducing valve to prevent damage to the same.
- The pressure reducing valve can be fitted vertically, horizontally or facing downwards.



RECOMMENDATIONS REGARDING ALLOWED WAYS OF CONNECTING THREADED FITTINGS:

To correctly seal threaded joints and fittings of hydraulic, hygienic, sanitary and industrial systems, we recommend using mastic, paste and/or products suitable for sealing these types of connections. It is not allowed to use flat and/or taper-seal type or any other type of gaskets.

MAIN COMPONENTS FOR USE WITH THE RINOX PRESSURE REDUCING VALVE

CODE	DESCRIPTION
3.03÷13.00, 3.03÷13.10, 3.03÷09.70, 3.03÷13.20	 Line filters with extractable filter cartridge. Max operating pressure: 16 bar. UNI-EN-ISO 228 thread. Filtering capacity from 800 µm to 50 µm.
858.04÷09.12 858.04÷09.02 858.04÷09.72	 Line filters with extractable filter cartridge. Max operating pressure: 16 bar. UNI-EN-ISO 228 thread. Filtering capacity from 800 µm to 100 µm.
126.03÷13.10	 Self-cleaning filter for water with extractable filter cartridge, complete with dial gauge and ball drain valve with connection via rubber hose connector. Max operating pressure: 16 bar. UNI-EN-ISO 228 thread. Standard filtering 100 µm.
2516.04÷06.00 583.07.00	 Self-cleaning filter for water with extractable filter cartridge and visual control of the degree of blockage, complete with double dial gauge and ball drain valve with connection via rubber hose connector. Max operating pressure: 16 bar. UNI-EN-ISO 228 thread. Standard filtering 100 µm.
Ranges 929, 930, 931, 959, 1041, 1156, 1171,1172, 1173, 1200, 1201, 1215, 6059, 6062, 6065, 6068, 6071, 6074	 Spare filters for in line Y filters, self-cleaning with single or double gauge.
304.04÷13.00	 Magnetic lime scale remover for physical water treatment. Max operating pressure: 16 bar. UNI-EN-ISO 228 thread.
67.04÷07.02, 67.04÷07.12	 Ball valve with total passage, control by butterfly knob, MF connections. UNI-EN-ISO 228 thread.
67.05.70, 67.06.70, 67.05.00, 67.06.00	 Ball valve with total passage for water, control by butterfly knob, MF connections with OR seal fitting. UNI-EN-ISO 228 thread.
72.04÷09.00, 72.06.50	 Straight MM union fitting in three pieces. Max operating pressure: 10 bar. UNI-EN-ISO 228 thread.
1100.05.00, 1100.06.00	 Straight MM union fitting in three pieces with OR seals on the connections. Max operating pressure: 10 bar. UNI-EN-ISO 228 thread.

SPECIFICATION ITEMS

SERIES 51

Adjustable compensated pressure reducing valve, with double seat in stainless steel, diaphragm operated, with anti-water hammer function, model *Rinox*. Suitable for channelling water. Nickel plated brass body. Stainless steel AISI 303. Nitrile seals. Threaded connections FF UNI-EN-ISO 228. Pressure gauge connection F 1/4". Max upstream pressure 4000 kPa. Max upstream pressure in compliance with standard NF 1600 kPa. Max operating temperature 80 °C. Default presetting 300 kPa (only size 1/2" - 3/4" - 1"). Outlet adjustment 80÷550 kPa, on-demand outlet adjustment 80÷700 kPa. Available sizes 1/2" ÷ 4" (or connection flanged DN65 ÷ DN100).

SERIES 51

Adjustable compensated pressure reducing valve, with double seat in stainless steel, diaphragm operated, with anti-water hammer function, model *Rinox*. Suitable for channelling water. Nickel plated brass body. Stainless steel AISI 303. Nitrile seals. Threaded union connections MM UNI-EN-ISO 228. Pressure gauge connection F 1/4". Max upstream pressure 4000 kPa. Max upstream pressure in compliance with standard NF 1600 kPa. Max operating temperature 80 °C. Default presetting 300 kPa (only size 1/2" - 3/4" - 1"). Outlet adjustment 80÷550 kPa, on-demand outlet adjustment 80÷700 kPa. Available sizes 1/2" ÷ 2".

SERIES 111

Pressure reduction unit indicate composed of adjustable compensated pressure reducing valve, stainless steel double seat diaphragm operated, with anti-water hammer function, model *Rinox*, dial pressure gauge, line filter with removable and interchangeable filtering cartridge. Nickel plated brass body. Stainless steel AISI 303. Nitrile seals. Threaded union connections MM UNI-EN-ISO 228. Pressure gauge connection F 1/4". Max upstream pressure 4000 kPa. Max upstream pressure in compliance with standard NF 1600 kPa. Max operating temperature 80 °C. Max filtering 800 micron. Default presetting 300 kPa (only size 1/2" - 3/4" - 1"). Pressure gauge scale 0÷16 bar. Outlet adjustment 80÷550 kPa, on-demand outlet adjustment 80÷700 kPa. Available sizes 1/2" ÷ 2".



RBM spa reserves the right to make improvements and changes to the product described and to its technical details (supplied only as guide indications) at any moment and without notice: always refer to: the instructions enclosed with the components supplied; this sheet is an aid if they prove to be too schematic. RBM assumes no responsibility for the results obtained, or for use contrasting possible existing patents. Please contact our technical office for any doubts, problems or clarification.

RBM Spa
Via S. Giuseppe, 1
25075 Nave (Brescia) Italy
Tel. 030-2537211 Fax 030-2531798
E-mail: info@rbm.eu - www.rbm.eu